

SOUTH MAIN HARDWARE

Modern Standard Toilet Paper Holder SH730-PC-1

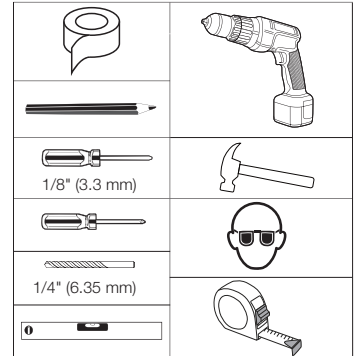

1

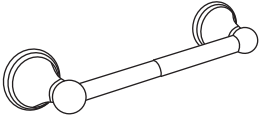
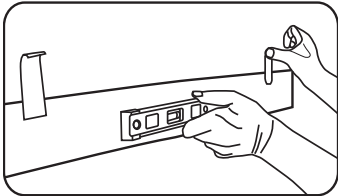

2

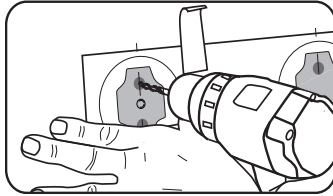

3

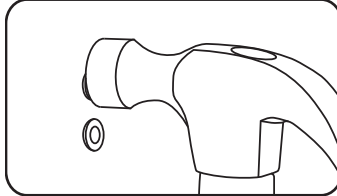

4

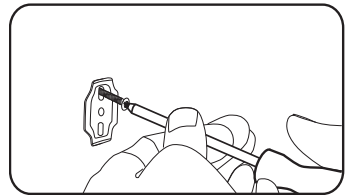

5

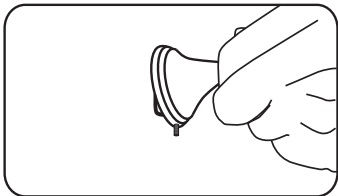

6

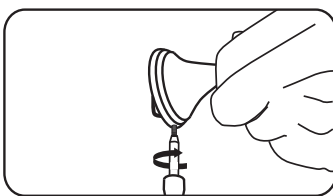

7

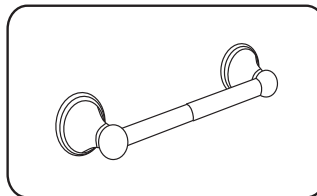

CAUTION

This product contains small items that could be a choking hazard if swallowed. Keep these items away from young children.

- Make Sure these instructions are read and completely understood before attempting installation. If you are unsure of any part of this installation, please contact a professional installer for assistance.

⚠ WARNING Maximum load: 11 lbs (5 kg).

Step 1: Determine where you would like to mount your bathroom hardware fixture by placing it on the wall. Mark your location with tape or a pencil. Make sure that both ends of the fixture are secured to the towel bar. Tape your mounting template to the wall covering your desired location. Ensure that the template is straight by aligning a level with the center line of the template.

Step 2: Using a drill and 1/4" (6.35 mm) drill bit, drill two vertical holes for each mounting bracket in the location specified on the template paper.

Step 3: Remove mounting template from the wall and insert plastic drywall anchors into all 4 drilled holes. Lightly tap with hammer until flush with wall.

Step 4: Position the mounting brackets against anchor holes and thread screws until secure.

Step 5: Using a 1/8" (3.3 mm) slotted screwdriver, loosen the metal set screw located at the base of each fixture. Loosen screw until fixture is able to rest flush over mounting bracket.

Step 6: Place fully-assembled fixture overtop the mounting bracket with set screws facing down. With the fixture resting on the wall, use 1/8" (3.3 mm) slotted screwdriver again to tighten the fixture onto the mounting bracket.

Step 7: Make sure the fixture is secured to the wall by gently moving both posts from side to side.

Installation Guide

